

THE PROPERTY OF THE DRAWING IS ESTABLISHED BY LAW. IT IS FORBIDDEN TO PRODUCE OR SHOW IT TO THIRD PART. WITHOUT A WRITTEN AGREEMENT.

Item	Name	Q.ty
1	CA.GWP.5U	1
2	R.5.SCH	1
3	V.TCE5x16	1
4	VTB.JU.281818	1

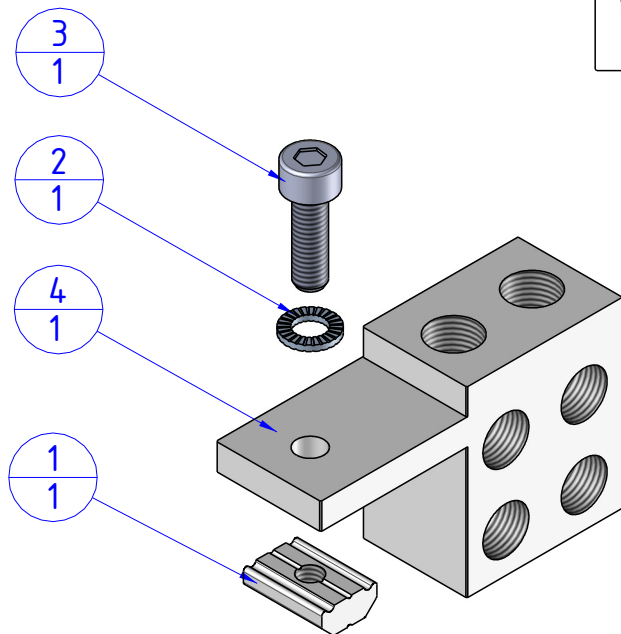
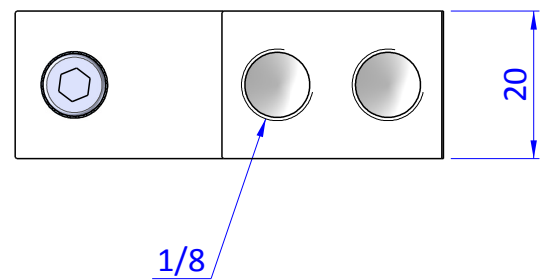
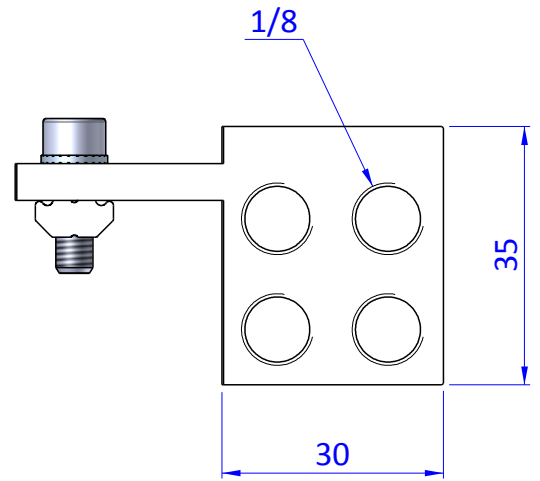

Format A4 UNI 936-76					DESIGNED FROM FPS Automation	REVIEW A
	GENERAL TOLERANCE UNI - ISO 2768 CLASSE f	DESCRIPTION CA.VTB.JU.281818			DATE 28/05/2019	WEIGHT 0,055kg
					CODE CA.VTB.JU.281818	